



# DOORS

Highlights of Architecture



COVER | WINNER INTERNORM ARCHITECTURE COMPETITION 2018 | PRIVATE CONSTRUCTION  
Entrance door AT 310 | Window KF 405, KF 410, KS 430

# CONTENT

## DOOR MODELS

Door leaf with glass cut-out	8
Solid door leaf	28
Door leaf with glass cut-out	32

## SECURITY

Safety features	34
-----------------	----

## PRESENTATION

Design	36
Overview technology	40
Handles	42
Colours	48

## COMPANY

We are offering you	52
Customer Care	53
Warranties	54
Certifications	55

[www.internorm.com](http://www.internorm.com)







### **SOLID YET SUSPENDED**

The white, clearly structured building seems to float above the white base. The timber-aluminium entrance door highlights this architectural solution.

Detached house (A), door: HT 410, window HF 310





### ALUNOX GLASS SURROUND

Draw attention to the simplicity and elegance of your entrance door in a discreet manner with an Alunox glass surround. The matt brushed glass surround. The matt brushed surface forms the ideal frame for your glass cut-out..



#### GG

Colour: HF113  
Handle: MGSE10  
Glass: Satinato white,  
Alunox glass surround  
Order no: 19-014

**AT 410** AT 400 AT 310 HT 400 HT 410



#### GA

Colour: frame HM716,  
Handle: HS42  
Glass: Satinato white  
Order no: 19-015

**AT 410** AT 400 AT 310 AT 305 HT 400 HT 410

**TIMBER APPEARANCE**

You want to see the timber  
appearance on the outside?  
Why don't you use  
HDS or HDH colours  
with vibrant timber grain?



**DA**

Colour: HDS08  
Handle: HS40  
Glass: Satinato white  
Order no: 19-016

AT 410 AT 400 AT 310 AT 305 HT 400 **HT 410**



**ELEGANCE**

The combination of high gloss and matt surfaces is especially attractive. The modern design is rounded off through stainless steel heavy duty joiners and a sophisticated glass insert.



**DL**

Colour: frame HM716, sash M916,  
SD04 high gloss black  
Handle: SG16  
Glass: Satinato white  
Designer elements: heavy duty joiners  
Order no: 19-017

AT 410 AT 400 AT 310 HT 400 HT 410



**DJ**

Colour: M916  
Handle: RGS02  
Glass: Satinato white  
Order no: 19-018

AT 310



## DOOR LEAF WITH GLASS CUT-OUT

### FRAMELESS SIDE ELEMENT

This entrance door looks stylish with frameless side elements. These are rendered into the brickwork and almost disappear completely. The insulating glass finishes flush with the door frame and looks elegant.



### DB

Colour: HM721  
Handle: FS20  
Glass: Satinato white  
Order no: 19-019

**AT 410** AT 400 AT 310 AT 305



**DD**

Colour: HM716  
 Handle: TEG15  
 Glass: Satinato white  
 Designer elements: heavy duty  
 joiners  
 Order no: 19-020

AT 410 AT 400 AT 310 HT 400 HT 410



**PN**

Colour: frame HM907,  
 sash HM907, M916  
 Handle: EGS06  
 Glass: Satinato white  
 Alunox glass surround  
 Order no: 19-021

AT 410 AT 400 AT 310 HT 400 HT 410

**NEW:**

Real wood with old wood look



**PA**

Colour: Frame HM721 - SD10  
Handle: HGS01  
Glass: Satinato White  
Order no: 20-026

**AT 410** AT 400 AT 310 AT 305 HT 400 HT 410



**PQ**

Colour: frame HM721,  
sash HM721, HM907  
Handle: SG18  
Glass: Satinato white  
Order no: 19-023

**AT 410** AT 400 AT 310 HT 400 HT 410







**PR**

Colour: HM716  
Handle: KGS03  
Glass: Satinato white  
Order no: 19-024

AT 410 AT 400 AT 310 HT 400 HT 410



**GJ**

Colour: M916  
Handle: MGSE10  
Glass: Satinato white  
Order no: 19-025

AT 410 AT 400 AT 310 HT 400 HT 410



**DM**

Colour: frame HFM12,  
sash HFM12, M916  
Handle: MGSE6  
Glass: Satinato white  
Order no: 19-026

AT 410 AT 400 AT 310 HT 400 HT 410



**GY**

Colour: HM704  
Handle: HS50  
Glass: Satinato white  
Order no: 19-027

AT 305

DOOR LEAF WITH  
GLASS CUT-OUT



**PD**

Colour: HM906

Handle: MGSE10

Glass: Satinato white

Order no: 19-028

AT 410 AT 400 AT 310 HT 400 HT 410



**TRADITIONAL**

Sustainable, ecological with a classic building style combined with modern window and door elements.

Entrance door AT 410 Art-Concrete,  
window KF 410





### BASE

Internorm entrance doors are available with or without Alunox base - for protection or as a designer element.



### DP

Colour: RAL5010  
Handle: MGSE6  
Glass: Satinato white,  
Alunox glass surround  
Order no: 19-029

**AT 310** HT 400



### PP

Colour: HFM12  
Handle: RGS05  
Glass: Satinato white  
Order no: 19-030

**AT 410** AT 400 AT 310 AT 305 HT 400 HT 410

**COMPACT DESIGN**

The glass of the side element meets directly with the door frame which connects with the door in one unit. Upon request, frame and door leaf can be designed in different colours.



**PJ**

Colour: HF113  
Handle: MGSE10  
Glass: Satinato white  
Order no: 19-031

AT 410 AT 400 AT 310 HT 400 HT 410









**PG**

Colour: HFM11  
Handle: RGS02  
Glass: Satinato white  
Order no: 19-032

AT 410 AT 400 **AT 310** AT 305 HT 400 HT 410



**PM**

Colour: HF113  
Handle: FS10  
Glass: Satinato white  
Order no: 19-033

AT 410 AT 400 **AT 310** AT 305 HT 400 HT 410



**PK**

Colour: M916  
Handle: RGS03  
Glass: Satinato white  
Order no: 19-034

AT 410 AT 400 AT 310 HT 400 HT 410



**DI**

Colour: frame HM907, sash M916  
Handle: SG13  
Glass: Satinato white  
Designer elements: heavy duty joiners  
Order no: 19-035

AT 410 AT 400 AT 310 HT 400 HT 410



**GJ**

Colour: frame HF735,  
sash HF735, HF716  
Handle: MGSE10  
Glass: Satinato white  
Order no: 19-011

**AT 410** AT 400 AT 310 HT 400 HT 410



**GD**

Colour: HFM05  
Handle: KGS04  
Glass: Satinato white  
Order no: 19-012

**AT 410** AT 400 AT 310 AT 305 HT 400 HT 410

DOOR LEAF WITH  
GLASS CUT-OUT



**DG**

Colour: M916  
Handle: SG17  
Glass: Satinato white,  
Alunox glass surround  
Order no: 19-013

**AT 410** AT 400 AT 310 HT 400 HT 410

### CONCRETE APPEARANCE

Each Art-Concrete entrance door demonstrates its own individual surface – each door is therefore unique.



### FK

Colour: frame RAL9017, sash SD03 Art-Concrete

Glass: Satinato white

Handle: SG13

Designer elements: heavy duty joiners

Order no: 19-007

**AT 410** AT 400 AT 310 HT 400 HT 410





**FM**

Colour: frame HM704,  
sash HM704, M916  
Handle: KGS03  
Order no: 19-008

AT 410 AT 400 AT 310 HT 400 HT 410



**FD**

Colour: frame HM716,  
sash HM716, HM907  
Handle: RGS05  
Order no: 19-009

AT 410 AT 400 AT 310 HT 400 HT 410

## TRENDSETTER

Our doors in Art-Stone, Art-Steel und Art-Corten are unique specimens. Each ceramic plate has its own individual surface. Additionally, the ceramic surface is scratch-resistant and always immaculate. Combined with heavy duty joiners or side elements they become the style element of each house.



### FA

Colour: frame HM716,  
sash SD06 Art-Steel  
Handle: KGS03  
Order no: upon technical request

AT 410 AT 400 AT 310



### FA

Colour: frame HM716,  
sash SD07 Art-Stone  
Handle: KGS04  
Order no: upon technical request

AT 410 AT 400 AT 310

**EXPERIENCE THE DOOR INTERACTIVELY**

Have a look at how the door could fit into your entrance area, look at it from all sides and change the surface. All this is possible now with the Internorm AR App.



Download your  
Internorm AR App  
for free in Google  
Play Store and  
iApple App Store



**FJ**

Colour: frame HM716,

sash SD05 Art-Corten

Handle: KGS04

Glass: Satinato white

Designer elements: heavy duty  
joiners

Order no: upon technical request

AT 410 AT 400 AT 310





**K RA-S1B**

Colour: HM704  
Handle: HS10  
Glass: Satinato white  
Order no: 19-060

AT 200



**K RA-G1B**

Colour: M916  
Handle: HS10  
Glass: MRI  
Order no: 19-061

AT 200



### GLASS FRAME

We are offering you doors with profiled glass frames for your home. These can be designed independently from the door leaf colours.



#### AM

Colour: M916  
Handle: HS10  
Glass: D03  
Order no: 19-040

AT 310



#### AJ

Colour: HM817  
Handle: VD14  
Glass: D41  
Order no: 19-041

AT 310





**AA**

Colour: HDS08  
Handle: BS11  
Glass: Satinato white  
Order no: 19-042

AT 400 AT 310 HT 400



**AG**

Colour: frame HF113,  
sash HF113, M916  
Handle: HS40  
Glass: Satinato white  
Order no: 19-043

AT 400 AT 310 HT 400

# YOUR FINGER IS THE KEY

No need to look for that key again due to the finger scanner or keypad. With Internorm, these technologically clever systems are fastened to the door leaf or integrated flush in the door leaf or handle.

**NEW**  
Door handle  
with integrated  
finger scanner!



## FINGER SCANNER

The integrated finger scanner replaces the conventional key in a convenient way without exception. The control unit is space-saving and securely situated in the door sash. Keys, cards or codes can no longer be forgotten, lost or stolen.

**Simple.** You can open the door by simply “sliding your fingers across”. You can save your own authorised individual meaning, no need for technicians.

**Convenient.** You always have your key “at hand”. This clever software is so intelligent that it learns with every scan and even recognises growth in children’s fingers or changes in user behaviour.

**Secure.** Your unique finger print is more secure than a key which can be lost or stolen. Control of the system from the outside is impossible. Removal of this is also impossible.

**Scanner generally with bluetooth (BT) interface** and optionally also with transponder. Programming and admin of finger scanner via Smartphone or tablet. The bluetooth connection is secured through a 6 digit coupling code. Suitable for Apple and Android phones or tablets.



## KEYPAD

The ekey home integrated keypad is fitted directly into the door sash or the wall next to the door. Only the ultra-flat decor element is visible.

The system is compatible with all e-openers and electric locks. A cable transports an encoded opening signal to an electronic relais. The relais sends an opening impulse to the electric lock. Control from the outside is therefore impossible.

Opening occurs by typing in a four to ten digit code of your choice. A six digit code is very secure and easy to remember. A pattern can even be taught via the touch screen and by mobile phones.

Up to 99 codes can be programmed. Each user can therefore have his own access code. For example, this option allows the code to be deleted and replaced with a new code as required.



## SECURE WITH WINKHAUS CYLINDERS

There is a multitude of additional components available such as high security cylinders, door blocks, signal lights etc. For more information please contact your Internorm [1<sup>st</sup>] window partner.



Symbolic photos

The **standard cylinder** is equipped with anti-scanning and drilling protection and two steel pins. It can be locked from both sides, this means, even if the key is in the lock on one door side, it can be locked or unlocked from the other side.

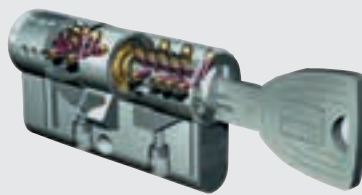

The **high security cylinder** with 3D patented antiscanning and drilling protection as well as being unable to remove or loosen. This specific key shape means smoothness of locking and prevents bending and breaking of the key. Lockable from both sides. The symmetrical reversible key can be easily inserted into the cylinder.



Each high security cylinder comes with a personal **security card**. It serves as important proof of legitimacy when reordering cylinders or keys.

## ADDED SECURITY



**Door block TSH** serves as opening limiter. It is operated outside via the main lock (no cylinder outside). Operation on the inside via a turn knob.

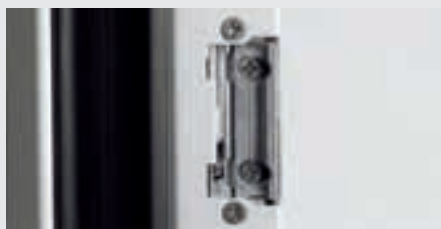

Door can only be opened while contact is given (button pressed) with the **electric door opener/ETOE**.

## AT A GLANCE



**Door spyhole** is available in chrome or brass.



## ELEGANT DESIGN

The frameless side element is a unique feature. Through three-sided rending into the brickwork, the frame almost disappears altogether. The insulating glass finishes flush with the door frame to reveal a modern appearance of the entrance area.

## ONE DOOR – MANY POSSIBILITIES

From simple to luxurious – the design of the entrance door is completely up to you. The rather discreet groove millings blend in perfectly with the design of the entrance door. Heavy duty joiners made from Alunox (flush) or stainless steel (raised) create a focal point.

Side elements made of glass ensure plenty of light for your home.



### FG

Colour: HM716  
Handle: MGSE10  
Designer elements: heavy duty joiners  
Order no: 19-084

**AT 410** AT 400 AT 310  
HT 400 HT 410



### FG

Colour: HM716  
Handle: MGSE10  
Designer elements: groove milling  
Order no: 19-085

**AT 410** AT 400 AT 310  
HT 400 HT 410



### FG

Colour: HM716  
Handle: MGSE10  
Glass: Satinato green  
Designer elements: heavy duty joiners  
Order no: 19-086

**AT 410** AT 400 AT 310 HT 400 HT 410

# HEAVY DUTY JOINERS AND GROOVE MILLINGS

Whether you want simple or elegant – both versions communicate charm in their own way. The rather discreet groove millings blend in perfectly with the design of the entrance door. Heavy duty joiners made from Alunox (flush) or stainless steel (raised) create a feature.



Groove milling



Heavy duty joiner

**FG**  
Colour: HFM13  
Handle: EGS01  
Order no: 19-087

- AT 410
- AT 400
- AT 310
- HT 400
- HT 410

**FG**  
Colour: HFM13  
Handle: EGS01  
Order no: 19-088

- AT 410
- AT 400
- AT 310
- HT 400
- HT 410



**HEAVY DUTY JOINERS**

These are available either flush in Alunox or raised in stainless steel.



Double groove milling



Double heavy duty joiner

**FJ**  
Colour: HFM22  
Handle: MGSE10  
Order no: 19-089

- AT 410
- AT 400
- AT 310
- HT 400
- HT 410

**FJ**  
Colour: HFM22  
Handle: MGSE10  
Order no: 19-090





- AT 410
- AT 400
- AT 310
- HT 400
- HT 410

## AT 410

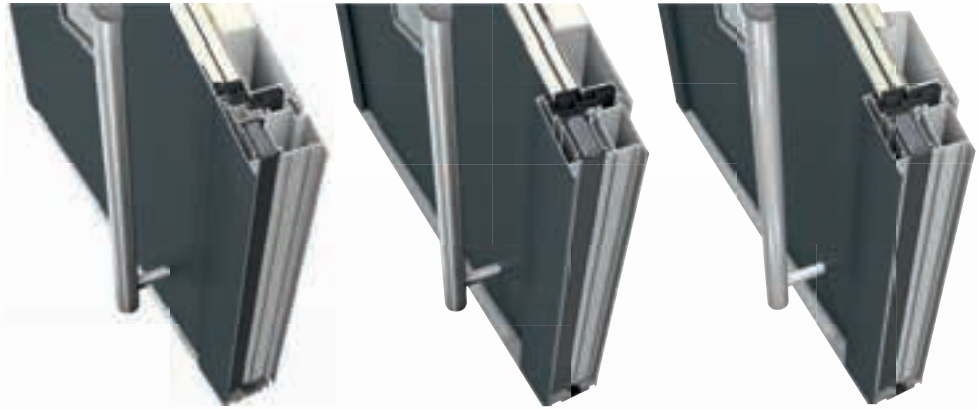
## AT 400

## AT 310



	AT 410	AT 400	AT 310
<b>Material</b>	Aluminium	Aluminium	Aluminium
<b>Thermal insulation</b> in W/(m <sup>2</sup> K)	 U <sub>b</sub> as low as 0.78	 U <sub>b</sub> as low as 0.75	 U <sub>b</sub> as low as 0.81
<b>Sound proofing</b> in dB	 up to 36	 up to 36	 up to 33
<b>Security</b>	 up to RC2	 up to RC2	 up to RC2
<b>Locking</b>	 Multi-point locking	 Multi-point locking	 Multi-point locking
<b>Profile construction depth</b> in mm	 93	 93	 93
<b>Gasket levels</b>	3	3	3
<b>Low threshold</b>	Thermally broken	Thermally broken	Thermally broken
<b>Insulation</b>	3-chamber frame profile foam insulation core	3-chamber frame profile foam insulation core	3-chamber frame profile foam insulation core
<b>Design style</b>	<div style="background-color: #4a86e8; color: white; padding: 5px; text-align: center;">studio</div>	<div style="background-color: #4a7c59; color: white; padding: 5px; text-align: center;">home pure</div> <div style="background-color: #4a7c59; color: white; padding: 5px; text-align: center;">home soft</div> <div style="background-color: #4a3d4d; color: white; padding: 5px; text-align: center;">ambiente</div>	<div style="background-color: #4a7c59; color: white; padding: 5px; text-align: center;">home pure</div> <div style="background-color: #4a7c59; color: white; padding: 5px; text-align: center;">home soft</div> <div style="background-color: #4a3d4d; color: white; padding: 5px; text-align: center;">ambiente</div>

**AT 305**

**AT 200**

**HT 410**

**HT 400**



Aluminium

Aluminium

Timber-aluminium

Timber-aluminium

$U_D$  as low as 0.98

$U_D$  as low as 1.2

$U_D$  as low as 0.58

$U_D$  as low as 0.73

up to 39

up to 39

up to 34

up to 34

up to RC2

up to RC2

up to RC2

up to RC2

Multi-point locking

Multi-point locking

Multi-point locking

Multi-point locking

93

80

121

85

3

3

3

3

Thermally broken

Thermally broken

Thermally broken

Thermally broken

3-chamber frame profile  
insulating glass core

3-chamber frame profile  
foam insulation core

Thermal foam insulation

Thermal foam insulation

home pure

home pure

studio

home pure

home soft

home soft

home soft

ambiente

ambiente

ambiente

# RECESSED HANDLES

Available attached and flush.

Only available attached with AT310.

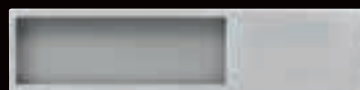

**SG16**  
Recessed handle, 430x100  
stainless steel  
AT310, AT400, AT410, HT400, HT410



**SG13**  
Recessed handle, 220x125  
stainless steel  
AT310, AT400, AT410,  
HT400, HT410



**SG17**  
Recessed handle,  
110x500  
stainless steel  
AT310, AT400, AT410  
HT400, HT410  
LED lighting available



**SG18**  
Recessed handle,  
110x1400  
stainless steel  
AT310, AT400, AT410  
HT400, HT410  
LED lighting available

# HANDLE PLATE



**FS10**  
Handle plate, 100x100  
stainless steel  
AT200, AT305, AT310, AT400,  
AT410, HT400, HT410

# BAR HANDLES

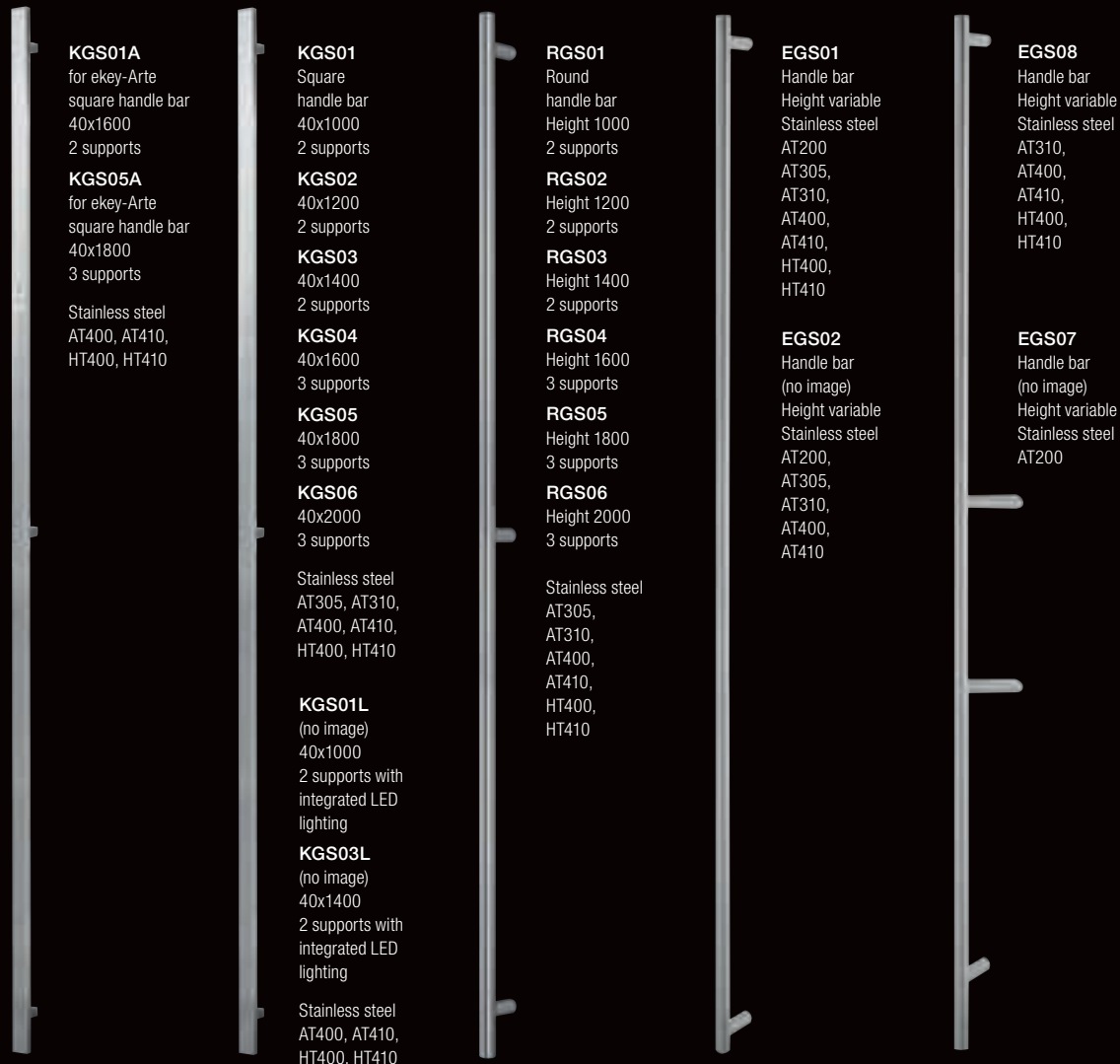

**KGS01A**  
for ekey-Arte  
square handle bar  
40x1600  
2 supports

**KGS05A**  
for ekey-Arte  
square handle bar  
40x1800  
3 supports

Stainless steel  
AT400, AT410,  
HT400, HT410

**KGS01**  
Square  
handle bar  
40x1000  
2 supports

**KGS02**  
40x1200  
2 supports

**KGS03**  
40x1400  
2 supports

**KGS04**  
40x1600  
3 supports

**KGS05**  
40x1800  
3 supports

**KGS06**  
40x2000  
3 supports

Stainless steel  
AT305, AT310,  
AT400, AT410,  
HT400, HT410

**KGS01L**  
(no image)  
40x1000  
2 supports with  
integrated LED  
lighting

**KGS03L**  
(no image)  
40x1400  
2 supports with  
integrated LED  
lighting

Stainless steel  
AT400, AT410,  
HT400, HT410

**RGS01**  
Round  
handle bar  
Height 1000  
2 supports

**RGS02**  
Height 1200  
2 supports

**RGS03**  
Height 1400  
2 supports

**RGS04**  
Height 1600  
3 supports

**RGS05**  
Height 1800  
3 supports

**RGS06**  
Height 2000  
3 supports

Stainless steel  
AT305,  
AT310,  
AT400,  
AT410,  
HT400,  
HT410

**EGS01**  
Handle bar  
Height variable  
Stainless steel  
AT200,  
AT305,  
AT310,  
AT400,  
AT410,  
HT400,  
HT410

**EGS02**  
Handle bar  
(no image)  
Height variable  
Stainless steel  
AT200,  
AT305,  
AT310,  
AT400,  
AT410

**EGS08**  
Handle bar  
Height variable  
Stainless steel  
AT310,  
AT400,  
AT410,  
HT400,  
HT410

**EGS07**  
Handle bar  
(no image)  
Height variable  
Stainless steel  
AT200

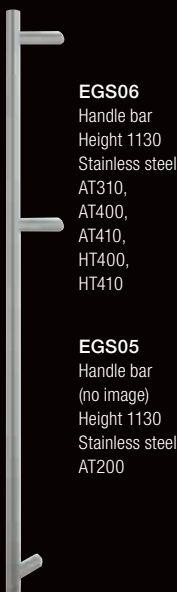

**EGS06**  
Handle bar  
Height 1130  
Stainless steel  
AT310,  
AT400,  
AT410,  
HT400,  
HT410

**EGS05**  
Handle bar  
(no image)  
Height 1130  
Stainless steel  
AT200



**MGSE6**  
Handle strap  
40x600

**MGSE8**  
Handle strap  
40x800

**MGSE10**  
Handle strap  
40x1000

Stainless steel  
AT310,  
AT400,  
AT410,  
HT400,  
HT410



**CS100**  
Handle bar  
Height 1000

Stainless steel  
AT200

An elegant selection of handles is available for each door series depending on the design style.

Please note that not every handle is available for every door series.

The handles are not displayed in proportion to each other and not in all material variations.

The dimensions are stated in mm, width x height or Ø.

# PUSH AND BOW HANDLES



**HS10**  
Push handle  
93x400  
stainless steel  
AT200, AT305, AT310,  
AT400, AT410,  
HT400, HT410



**HS50**  
Push handle  
109x500  
stainless steel  
AT200, AT305, AT310,  
AT400, AT410,  
HT400, HT410



**HS40**  
Push handle  
90x500  
stainless steel matt  
AT200, AT305, AT310,  
AT400, AT410,  
HT400, HT410



**HS42**  
Push handle  
90x500  
stainless steel  
AT200, AT305, AT310,  
AT400, AT410,  
HT400, HT410



**FS20**  
Push handle  
122x390  
stainless steel  
AT200, AT305, AT310,  
AT400, AT410,  
HT400, HT410



**TEG14**  
Push handle  
105x450  
stainless steel  
AT200, AT305, AT310,  
AT400, AT410,  
HT400, HT410



**TEG15**  
Push handle  
48x450  
stainless steel  
AT200, AT305, AT310,  
AT400, AT410,  
HT400, HT410



**HS32**  
Push handle  
118x477  
stainless steel  
(HS30 = ring  
stainless steel matt)  
AT200, AT305, AT310,  
AT400, AT410,  
HT400, HT410



**TEG10**  
Push handle  
110x330  
stainless steel  
AT200, AT305, AT310,  
AT400, AT410,  
HT400, HT410



**TEG13**  
Push handle  
155x550  
stainless steel  
AT200, AT305, AT310,  
AT400, AT410,  
HT400, HT410

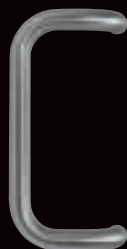

**PB30**  
Tube handle  
100x300  
stainless steel  
(PB31 = aluminium F1)  
AT200

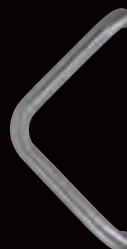

**PB20**  
Tube handle  
171x350  
stainless steel  
(PB21 = aluminium F1)  
AT200



**TEG12**  
Push handle  
110x330  
stainless steel  
AT200, AT305, AT310,  
AT400, AT410,  
HT400, HT410



**BS10**  
Push handle  
66x340  
stainless steel  
(BS11 =  
brass PVD)  
AT200, AT305, AT310,  
AT400, HT400



**BS42**  
Push handle  
68x340  
stainless steel  
(BS43 =  
brass PVD)  
AT200, AT305, AT310,  
AT400, HT400



**BS23**  
Push handle  
68x340  
brass PVD  
(BS22 = stainless steel)  
AT200, AT305, AT310,  
AT400, HT400



**GKN201**  
Stainless steel  
AT200



## LEVERS



**GD25**  
Stainless steel  
AT200, AT305, AT310, AT400,  
AT410, HT400, HT410



**PD12**  
Aluminium brushed  
AT305, AT310,  
AT400, AT410



**PD13**  
Chrome satin  
AT200, AT305, AT310, AT400,  
AT410, HT400, HT410



**PD15**  
Chrome satin  
AT305, AT310,  
AT400, AT410



**VD20**  
Chrome matt  
AT200, AT305, AT310, AT400,  
AT410, HT400, HT410



**GD10**  
Stainless steel  
AT200, AT305, AT310, AT400,  
AT410, HT400, HT410



**GD15**  
Stainless steel  
AT200, AT305, AT310,  
AT400, AT410, HT400, HT410



**GD20**  
Stainless steel  
AT200, AT305, AT310, AT400,  
AT410, HT400, HT410



**VD10**  
Chrome matt  
AT200, AT305, AT310,  
AT400, AT410, HT400, HT410



**VD12**  
Chrome matt  
(VD13 = brass PVD)  
AT200, AT305, AT310,  
AT400, AT410, HT400, HT410



**VD14**  
Chrome matt  
(VD15 = brass PVD)  
AT200, AT305, AT310, AT400,  
AT410, HT400, HT410



**VD16**  
Chrome matt  
AT200, AT305, AT310, AT400,  
AT410, HT400, HT410



**MD13**  
Stainless steel  
(MD10 = aluminium white)  
(MD12 = aluminium natural)  
(MD14 = brass PVD)  
AT200, AT305, AT310



**GD30**  
Stainless steel  
AT200, AT305, AT310,  
AT400, AT410, HT400,  
HT410

# HANDLE PLATE SETS

exclusively for AT 200



**VSD10**  
Chrome matt  
(VSK13 = brass PVD)



**VSK10**  
Chrome matt



**VSK14**  
Chrome matt  
(VSK15 = brass PVD)

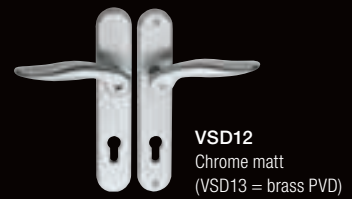

**VSD12**  
Chrome matt  
(VSD13 = brass PVD)



**VSK12**  
Chrome matt  
(VSK13 = brass PVD)



**PZD12**  
Aluminium natural  
(PZD11 = stainless steel)



**PSD61**  
Stainless steel



**PSK61**  
Stainless steel



**PSK11**  
Stainless steel  
(PSK12 = aluminium natural)

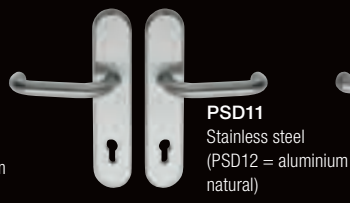

**PSD11**  
Stainless steel  
(PSD12 = aluminium natural)



**MSD13**  
Stainless steel  
(MSD10 = RAL9016)  
(MSD12 = aluminium natural)  
(MSD14 = brass PVD)



**MSB12**  
Aluminium natural  
(MSB10 = RAL9016)  
(MSB13 = stainless steel)  
(MSB14 = brass PVD)



**PZK12**  
Aluminium natural  
(PZK11 = stainless steel)



**PSD30**  
Brass PVD



**PSK30**  
Brass PVD



**VSD15**  
Brass PVD  
(VSD14 = chrome matt)

# HANDLE ACCESSORIES

exclusively for AT 200

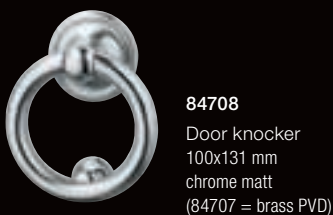

**84708**  
Door knocker  
100x131 mm  
chrome matt  
(84707 = brass PVD)



**84703**  
Door knocker  
110x177 mm  
brass PVD



**84701**  
Door knocker  
88x126 mm  
brass PVD  
(84702 = chrome matt)



# OUTSIDE & INSIDE COLOURS

Please note that not every colour is available for every door or frame or door leaf.

Due to printing and manufacturing technology colour deviations between illustrations in this brochure and original products may occur.

Your **Internorm [1<sup>st</sup>] window partner / distribution partner** will gladly advise you and show you original colour samples.

\* **Highly weather-resistant**, except M916 (facade quality).

\*\* Intensive colour appearance, however colour tolerances possible.

\*\*\* **HDH colours** have a vibrant timber appearance being hand-finished with structure coating, however colour tolerances are possible.

\*\*\*\* A special highly weather-resistant powder coating is used for surface versions **HM** (highly weather-resistant standard colour), **HF** (highly weather-resistant fine structure), **HFM** (highly weather-resistant fine structure metallic) and **HDH** (highly weather-resistant timber decor colour).

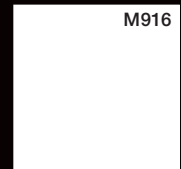

## STANDARD COLOURS\*



## TIMBER DECOR COLOURS\*\*\*



## HDS COLOURS\*\*

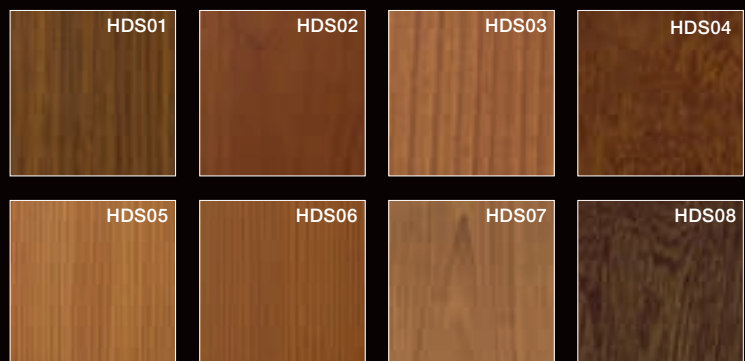

hirest COLOURS\*\*\*\*



METALLIC DECOR

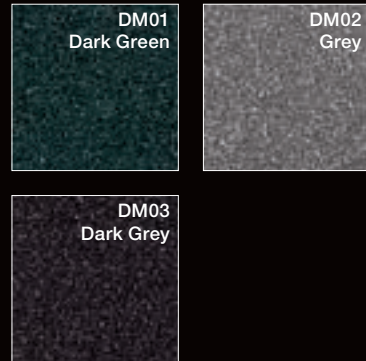

STAINLESS STEEL COLOURS

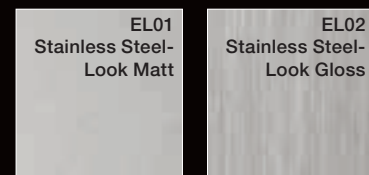

SPECIAL COLOURS

A variety of design possibilities is offered by the Internorm RAL colour range.

OUTSIDE COLOURS

SD COLOURS

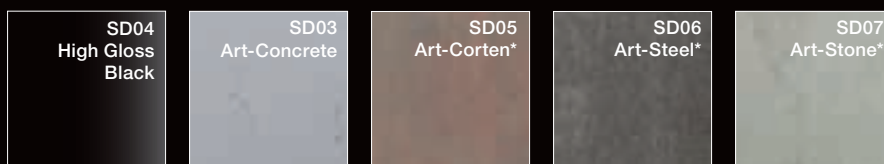

\*upon technical request

# INSIDE COLOURS

## TIMBER STANDARD COLOURS

### SPRUCE

varnished

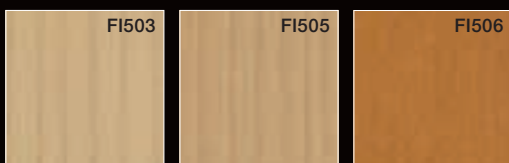

### SPRUCE

opaque

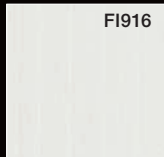

### ASH

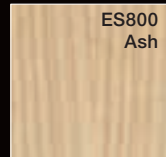

### WALNUT

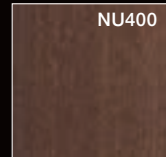

### OAK

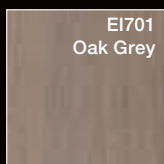

### LARCH

varnished

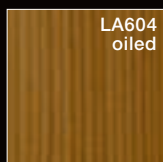
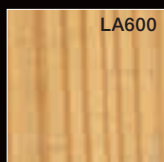







# WE ARE OFFERING YOU

## TRENDSETTING PRODUCTS FOR SOPHISTICATED CUSTOMERS.

### **INDIVIDUAL DOORS**

Each Internorm door is a unique example as it is manufactured according to your individual specifications and made to measure in our modern manufacturing site in Upper Austria.

We are producing aluminium or timber-aluminium doors for you with flush, square-edged, profiled or rounded door sash design.

A large selection of colours, glazing and handles offers almost limitless design possibilities. **Completely according to your wishes!**

### **INNOVATIVE TECHNOLOGIES**

Our company research department is continuously developing new products and technologies to ensure even more comfort and security for you. We are implementing these developments in our production sites in Austria with the help of most modern technologies.

### **EXCELLENT QUALITY**

Exceptional thermal insulation values and perfect security are matter of fact with Internorm doors. The large numbers of national and international awards and certifications testify of our leading role in development and

manufacture of the most modern windows and doors. We are convinced of our products and our service. Thus we issue warranties which surpass the usual market degree.

### **PERFECT COMBINATION**

Internorm entrance doors can be perfectly combined with any other product from the Internorm range. Same surface structures, colours and glazing enable a design continuity for your house.





**TRAUN/UPPER AUSTRIA**

Internorm/IFN Headquarters, UPVC window, insulating glass and aluminium production, door production



**SARLEINSBACH/UPPER AUSTRIA**

UPVC window and insulating glass production, extrusion



**LANNACH/STYRIA**

Timber-aluminium production

**PROFESSIONAL ADVICE**

We are only satisfied once you are satisfied! For this reason we have developed the unique Customer Care Program which guarantees you reliable advice and care. More than 1300 distribution partners in 21 countries vouch for this requirement. They accommodate your individual wishes, advise you professionally, take original measurements at your home and provide you with a clear quote.

**PROFESSIONAL INSTALLATION**

Certified installation specialists of our distribution partners will guarantee you clean and professional installations according to the valid guidelines. After installation they will check all installed products for full functionality with you and will pass on valuable tips for maintenance and care.

# WARRANTIES

WE GUARANTEE YOU MANY YEARS OF PLEASURE WITH YOUR INTERNORM WINDOWS.

As Europe's leading and largest active international window brand, Internorm looks back on 87 years of experience in trendsetting window and door solutions of exceptional reliability and longevity. This, we can guarantee you.

---

## Warranty

**15**  
YEARS

- No condensation between the panes of insulating glass up to a glass weight of 80kg.

---

## Warranty

**10**  
YEARS

- No unnatural colour changes or cracked surfaces due to weather influences for white window and door profiles made of UPVC, with the exception of mitre cracks.
- No unnatural colour changes or cracked inside surfaces due to weather influences for foil-coated window and door profiles made of UPVC, with the exception of mitre cracks.
- No unnatural colour changes or cracked surfaces due to weather influences for anodised or powder coated window and door profiles made of aluminium.
- No condensation between the panes of insulating glass.
- The function of the timber, thermal foam and aluminium profile compounds is guaranteed for all Internorm timber/aluminium window systems, provided that the Internorm installation and maintenance guidelines have been adhered to.
- The function of the adhesive and the sealing of insulation glass panes with the window profiles is guaranteed for all Internorm timber/aluminium window systems, provided that the Internorm installation and maintenance guidelines have been adhered to.
- The glue connection of glued Georgian/feature bars.

---

## Warranty

**5**  
YEARS

- PVD coated door handles are guaranteed against corrosion if there is no mechanical change.
- No unnatural colour changes or surface cracks due to weather influences in door fillings. There is no guarantee for changes in the surface appearance as a result of dirt.

---

## Warranty

**3**  
YEARS

- No unnatural colour changes or surface cracks due to weather influences for roller shutter profiles made of UPVC.
- No unnatural colour changes or surface cracks due to weather influences for anodised or powder coated roller shutter and blind profiles made of aluminium.
- The function of the window or door fitting is guaranteed, provided that the Internorm installation and maintenance guidelines have been adhered to.

---

### WARRANTIES/EXCERPT:

The full wording of our warranty conditions, the exact preconditions for the application of the warranty, and what you should do in the event of a claim, can be found in the Internorm Maintenance Care and Warranties Manual. You will receive this booklet when your Internorm products are delivered. In addition, it is obtainable from any Internorm [1<sup>st</sup>] window partner / distribution partner.

## NATIONAL AND INTERNATIONAL CERTIFICATIONS CONFIRM THE HIGH QUALITY OF OUR PRODUCTS.

Our know-how gives you the security that you receive best service for your money. The most modern production facilities and strictest quality controls ensure quality which is setting standards all over Europe. Awards of independent test institutes from all over Europe are confirming this.



Austrian State Emblem



Austrian Quality Label



CE Certification



TÜV



Institute for Window Technology Rosenheim



Plus X Award



RAL Quality Seals



Federal Ministry for Traffic, Innovation and Technology



Technical University Graz



Minergie® Certificate



Austrian Society for Environment Simulation



Certificate for Sustainable Forest Management

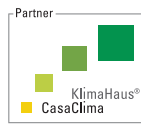

KlimaHaus Certificate



Energy Globe (Projekt Schiesthaus)



Climate Association Town Traun



VinylPlus Certificate



### IMPRINT

**Publisher:** Internorm International GmbH, Ganglgutstraße 131, A-4050 Traun

**Photos:** Studio Hoflehner, A-4600 Wels | studio46, A-4863 Seewalchen am Attersee

Isa Stein, Studio für Kunst and Architektur, A-4020 Linz | Internorm International GmbH, A-4050 Traun

**Design and Litho:** Internorm International GmbH, A-4050 Traun

**Print:** SRPM Limited, Hednesford, WS12 2HA

Subject to technical changes, layout and printing errors.

Internorm International GmbH is an ARA licence partner: Our licence number is 4477.

# Internorm®

## HEAD OFFICE

### **Internorm Windows UK Ltd**

Unit D, Colindale Business Park  
2-10 Carlisle Road, NW9 0HN, London  
Tel.: +44 (0) 208 205 9991  
Fax: +44 (01) 208 905 8744  
Email: [office@internorm.co.uk](mailto:office@internorm.co.uk)

[www.internorm.com](http://www.internorm.com)

